

User's Guide



ADI-8 DS

A true Industry Standard

SyncAlign™

SyncCheck™

Intelligent Clock Control™

Hi-Precision 24 Bit / 96 kHz
8 Channel AD / DA-Converter
ADAT® optical / TDIF®-1 Interface
Digital 24 Bit Interface / Format Converter



TDIF-1
24 Bit Interface

Important Safety Instructions



ATTENTION! Do not open chassis – risk of electric shock

The unit has non-isolated live parts inside. No user serviceable parts inside. Refer service to qualified service personnel.



Mains

- The device must be earthed – never use it without proper grounding
- Do not use defective power cords
- Operation of the device is limited to the manual
- Use same type of fuse only



To reduce the risk of fire or electric shock do not expose this device to rain or moisture. Prevent moisture and water from entering the device. Never leave a pot with liquid on top of the device. Do not use this product near water, i. e. swimming pool, bathtub or wet basement. Danger of condensation inside – don't turn on before the device has reached room temperature.



Installation

Surface may become hot during operation – ensure sufficient ventilation. Avoid direct sun light and do not place it near other sources of heat, like radiators or stoves. When mounting in a rack, leave some space between this device and others for ventilation.



Unauthorized servicing/repair voids warranty. Only use accessories specified by the manufacturer.



Read the manual completely. It includes all information necessary to use and operate this device.

Contents

1	Introduction	4
2	Supplied Contents	4
3	Brief Description and Characteristics	4
4	Technical Specifications	5
4.1	Analog Specs	5
4.2	Digital Specs	5
5	First Usage - Quick Start	6
6	Inputs and Outputs	
6.1	Analog Inputs	7
6.2	Analog Outputs	8
6.3	Digital Inputs	9
6.4	Digital Outputs	10
6.5	Word Clock Input and Output	11
7	Clock Section	12
8	Word Clock	
8.1	Operation and Technical Background	13
8.2	Cabling and Termination	13
9	Special Functions	
9.1	Bit Split	15
9.2	Combine	15
9.3	Copy Mode	16
9.4	Dither	17
9.5	DS - Double Speed	18
9.6	Noise level in DS mode	18
10	Controls and Connectors	19
11	Connector Pinouts	20
12	Block Diagram	21
13	Warranty	22
14	Appendix	22

1. Introduction

Congratulations on your purchase of the ADI-8 DS. This hi-quality analog to digital and digital to analog converter includes ADAT optical and TDIF-1 digital interfaces. It precisely converts analog audio data into a digital data stream and into the format of your choice. Newest circuit technology combined with latest integrated circuits result in a unique and outstanding device, meeting highest quality standards. The ADI-8 DS will excite you even after many years of operation.

2. Supplied Contents

Please ensure that all the following parts are included in ADI-8 DS' packaging box:

- ADI-8 DS
- Manual
- Power cord
- 2 x 2m optical cable (TOSLINK)

3. Brief Description and Characteristics

The ADI-8 DS is an 8-channel analog to digital and digital to analog converter in a 19" rack-mount enclosure of 1 U height. Latest 24 bit / 96 kHz converters offer 117 dBA dynamic ratio. This value is not only printed in the brochure, thanks to our Low Jitter Design it is available with every sold unit.

The servo balanced analog inputs and outputs are fitted with both D-sub (for optional XLR multicore) and 1/4" TRS jacks. The signal path from the jacks to the ADC is totally balanced. Both signal paths A/D and D/A are internally DC-coupled, for highest phase accuracy at lowest roll-off. The digital inputs and outputs are available as ADAT optical and TDIF-1 connectors.

To maintain the full dynamic range within the best operating level RME's ADI-8 DS includes electronic switches of the newest technology, which introduce no additional noise or distortion to the audio path. Two switches on the front panel let you control input and output level for a perfect adaptation to the most often used standards -10 dBV and +4 dBu. Each analog input has a 'Signal Ok' and 'Over' LED, so levels and Overload are easy to check.

The AD-converter can provide several internal clocks (44.1, 48, 88.2 kHz, 96 kHz). The unique Intelligent Clock Control technology (ICC) enables a flexible operation with internal clock, external word clock or the digital input signal. These options, also available for the DA-conversion, are easy to understand and easy to use. The current state of locking and clock synchronisation is shown by blinking or constant lit LEDs.

The digital section of the ADI-8 DS includes three outstanding functions. *Bit Split* allows to split one 24 bit signal to two 16 bit outputs. This technique allows for example to use two 8-channel 16 bit tape recorders to record 8 channels in 24 bit resolution. Using *Bit Combine* will put the split signals back to one full 24 bit signal. The method of splitting/combining is compatible to Yamaha's digital mixing desk 02R, so the ADI-8 DS can be used directly in 24 bit operation with this desk! Recording to 16 bit devices without using *Bit Split* (avoiding the double number of channels) can be done at highest sonic quality using the ADI-8 DS' *Dither* Option.

Furthermore the unique *Copy Mode* allows to use the device completely in digital domain. *Copy Mode* routes the digital input to the digital outputs ADAT and TDIF. As these operate simultaneously with identical data the ADI-8 DS not only turns into a superior ADAT/TDIF converter but also allows copying between devices of the same format and a distribution to different devices. In *Copy Mode* both *Bit Split* and *Combine* are also available, so the functionality is boosted again. That's why we call our ADI-8 DS an *Intelligent Audio Solution*.

4. Technical Specifications

- Power supply: Internal, 100-240 V AC, 30 Watts
- Typical power consumption: 12 Watts
- Dimensions including rack ears (WxHxD): 483 x 44 x 242 mm (19" x 1.73" x 9.5")
- Dimensions without rack ears/handles (WxHxD): 436 x 44 x 235 mm (17.2" x 1.73" x 9.3")
- Weight: 2 kg (4.4 lbs)
- Temperature range: +5° up to +50° Celsius (41° F up to 122°F)
- Relative humidity: < 75%, non condensing

4.1 Analog Specs

AD

- Resolution AD: 24 bit
- Signal to Noise ratio: 113 dB RMS unweighted, 117 dBA
- THD: < -110 dB, < 0.00032 %
- THD+N: < -104 dB, < 0.00063 %
- Crosstalk: > 130 dB
- Maximum input level AD: +19 dBu
- Frequency response AD, -0.1 dB: 5 Hz – 21.5 kHz
- Input Line: 1/4" TRS and 25 pin D-sub, servo balanced
- Input impedance Line: 10 kOhm
- Input sensitivity switchable: +4 dBu, -10 dBV, Lo Gain
- Input level for 0 dBFS @ Lo Gain: +19 dBu
- Input level for 0 dBFS @ +4 dBu: +13 dBu
- Input level for 0 dBFS @ -10 dBV: +2 dBV

DA

- Resolution DA: 24 Bit
- Dynamic Range: 112 dBA (unmuted)
- THD: < -104 dB, < 0.00063 %
- THD+N: < -102 dB, < 0.0008 %
- Crosstalk: > 110 dB
- Maximum output level DA: +19 dBu
- Frequency response DA, -0.1 dB: 5 Hz - 21,6 kHz
- Output Line: 1/4" TRS and 25 pin D-sub, servo balanced
- Output impedance Line: 47 Ohm
- Output level switchable: Hi Gain, +4 dBu, -10 dBV
- Output level at 0 dBFS @ Hi Gain: +19 dBu
- Output level at 0 dBFS @ +4 dBu: +13 dBu
- Output level at 0 dBFS @ -10 dBV: +2 dBV

4.2 Digital Specs

- Super Low Jitter Design: < 4 ns word clock PLL, < 1 ns ADAT PLL, < 1 ns internal
- Internal sample rates: 44.1 kHz, 48 kHz, 88.2 kHz, 96 kHz
- Word clock In range: 27 kHz - 57 kHz
- Internal resolution: 24 bit
- Outputs: ADAT optical (24 bit), TDIF-1 (24 bit), word clock
- Inputs: ADAT optical (24 bit), TDIF-1 (24 bit), word clock
- ADAT In clock range: 33 kHz - 57 kHz
- Bit Split: 24 bit to 1 channel 16 bit and 1 channel 8 bit
- Sample Split: 96 kHz to 2 channels of 48 kHz
- Copy Mode: Direct 24 bit copying from ADAT to ADAT/TDIF and vice versa
- Dither: 1 LSB TPDF switchable

5. First Usage - Quick Start

The clearly structured front panel design ensures an easy start when working with the device for the first time. Nevertheless we recommend to study at least the chapters 'Clock Section' and 'Copy Mode', as the extensive usage of format converter and clock options may result in some behaviour that may require further explanation. We therefore recommend to carefully study chapter 7 (Clock section) and 8.3 (Copy Mode).

Connect the TRS-jacks (or the D-sub connector) with the analog signal source. Change the input sensitivity by pressing INPUT LEVEL until the input level is sufficient to avoid noisy operation. Try to achieve an optimum input level by adjusting the source itself. Raise the source's output level until the Over LEDs flash at the loudest parts of the signal, then reduce the level a bit until no more Overs are detected.

The analog line inputs of the ADI-8 DS can be used with +4 dBu and -10 dBV signals. They are fitted with both D-sub (for an optional XLR multicore) and 1/4" TRS jacks. Both are internally connected, so not operational at the same time. The electronic input stage is built in a servo balanced design which handles monaural and stereo jacks correctly. When used unbalanced it automatically corrects the gain by 6 dB.

When switched on for the first time the ADI-8 DS starts in a default mode which should be suitable for most applications:

- AD-converter in master mode (CLOCK INTERNAL)
- DA-converter in slave mode (CLOCK INPUT)
- Sample rate 44.1 kHz
- Input ADAT optical

On the DA-side you just have to choose the desired digital input by pressing DIGITAL INPUT. A coarse correction of the analog output level can be done by pressing OUTPUT LEVEL.

The ADI-8 DS stores all current settings and automatically activates them when the device is turned on.

Transferring digital data into a computer is best done using RME's interface systems, like the Hammerfall[®] DSP and Fireface series. These hi-quality interfaces for PCI, PCIe and FireWire come with drivers for all popular operating systems. They have a world wide reputation as ultimate solution for master and multitrack tasks.

6. Inputs and Outputs

6.1 Analog Inputs

The ADI-8 DS back provides 8 (stereo) 1/4" TRS jacks and a 25 pin D-sub jack. Both are internally connected, so not operational at the same time. The electronic input stage is built in a servo balanced design which handles monaural and stereo jacks correctly. When used unbalanced it automatically corrects the gain by 6 dB.

 *When using unbalanced cables with XLR jacks pin 3 of the cable's jack should be connected to pin 1 (ground). Otherwise noise may occur, caused by the unconnected negative input of the ADI's balanced input.*

The 25-pin D-sub connector follows the pinout known from devices manufactured by Tascam. Refer to chapter 10 for a pinout listing. We do not recommend to make such a cable by yourself, as it is extremely difficult to integrate 8 balanced lines into a small D-sub housing without shorts. Your dealer will be glad to provide you with a professional Tascam multicore, D-sub to XLR, made in the length of your choice.

One of the main issues when working with an AD-converter is to maintain the full dynamic range within the best operating level. Because of this RME's ADI-8 DS includes electronic switches of the newest technology, which introduce no additional noise or distortion to the audio path. The key INPUT LEVEL allows a perfect adaptation for all 8 channels to the most often used levels -10 dBV and +4 dBu.

Each analog input has a 'Signal Ok' and 'Over' LED, so levels and Overload of each channel are easy to check. The green LED begins to light at -40 dBFS in an analog fashion (more bright at higher levels). When this LED lights up only seldom or never, the input level is too low, causing a noisy and distorted recording. The red LED lights up 2 dB before reaching maximum level (-2 dBFS) to securely prevent overload of the analog input.

The 'standardized' studio levels do not result in a (often desired) full scale level, but take some additional digital headroom into consideration. The amount of headroom is different in different standards and again differently implemented by different manufacturers. Because of this we decided to define the levels of the ADI-8 DS in a most compatible way. The headroom of the ADI-8 DS is defined according to the chosen reference level.

Reference	0 dBFS @	Headroom
Lo Gain	+19 dBu	15 dB
+4 dBu	+13 dBu	9 dB
-10 dBV	+2 dBV	12 dB

At +4 dBu a headroom of 9 dB offers a problem-free operation with most devices, and meets the latest EBU recommendations for Broadcast usage. At -10 dBV 12 to 15 dB headroom are common practice, each mixing desk operating at -10 dBV is able to send and receive much higher levels. Lo Gain allows to work with high levels, best suited for professional users who prefer to work balanced and at highest levels.

6.2 Analog Outputs

The 8 short circuit protected, low impedance and servo balanced line outputs are available as (stereo) 1/4" TRS jacks and 25 pin D-sub jack. Both are internally connected, and - in contrary to the inputs - can be used simultaneously. The electronic output stage is built in a servo balanced design which handles monaural and stereo jacks correctly. When used unbalanced it automatically corrects the gain by 6 dB.

The 25-pin D-sub connector follows the pinout known from devices manufactured by Tascam. Refer to chapter 10 for a pinout listing. We do not recommend to make such a cable by yourself, as it is extremely difficult to integrate 8 balanced lines into a small D-sub housing without short circuits. Your dealer will be glad to provide you with a professional Tascam multicore, D-sub to XLR, made in the length of your choice.

To maintain an optimum level for devices connected to the analog outputs the ADI-8 DS includes electronic switches of the newest technology, which introduce no additional noise or distortion to the audio path. The key OUTPUT LEVEL allows to change the output level of all 8 channels simultaneous to the most often used -10 dBV and +4 dBu.

Each analog output has its own 'Signal Ok' LED, so a signal at the analog outputs is visually indicated. The green LED begins to light at -40 dBFS in an analog fashion (brighter at higher levels).

As with the analog inputs the analog output levels do not follow any single standard, but are designed to maintain a problem-free operation with most other devices. The headroom of the ADI-8 DS is defined according to the chosen reference level.

Reference	0 dBFS @	Headroom
Hi Gain	+19 dBu	15 dB
+4 dBu	+13 dBu	9 dB
-10 dBV	+2 dBV	12 dB

At +4 dBu a headroom of 9 dB offers a problem-free operation with most devices, and meets the latest EBU recommendations for Broadcast usage. At -10 dBV 12 to 15 dB headroom are common practice, each mixing desk operating at -10 dBV is able to send and receive much higher levels. Hi Gain results in maximum level for professional users who prefer to work balanced and at highest levels.

6.3 Digital Inputs

The ADI-8 DS provides two digital inputs, both in ADAT optical and TDIF-1 format. In normal operation only the MAIN inputs are used. When using more than the first 4 channels at activated COMBINE BS (Bit Split) or DS (Double Speed), the AUX inputs also have to be used.

The key DIGITAL INPUT sets the desired input active.

The ADAT optical inputs of the ADI-8 DS are fully compatible with all ADAT optical outputs. RME's unsurpassed Bitclock PLL prevents clicks and drop outs even in extreme varipitch operation, and guarantees a fast and low jitter lock to the digital input signal. A usual TOSLINK cable is sufficient for connection.

ADAT Main

Interface for the first or only device sending an ADAT signal to the ADI-8 DS. Carries the channels 1 to 8. When receiving a Bit Split or Double Speed signal, this input carries the channels 1 to 4.

ADAT AUX

Only necessary in COMBINE and DS mode. Interface for the second device sending a Bit Split or Sample Split signal to the ADI-8 DS. Carries the channels 5 to 8.

The TDIF-1 connectors of the ADI-8 DS are fully compatible with all devices offering such an interface, for example DA-38 and DA-88. A low jitter PLL ensures best playback sound quality and reliable operation. RME's exclusive SyncCheck verifies synchronous operation when using both TDIF ports. The connection is done through a special TDIF cable, available at your local dealer (Tascam part number PW-88D).

TDIF Main

Interface for the first or only device with a TDIF-1 interface. Carries the channels 1 to 8. When transmitting a Bit Split or Double Speed signal, this port carries the channels 1 to 4.

TDIF AUX

Copy of the data at the MAIN interface. Carries the channels 5 to 8 in Bit Split or Double Speed mode.

General hints on TDIF operation

TDIF and word clock

When the ADI-8 DS is slave no additional word clock connection is necessary. In case DA88 and/or DA38 are slave the word clock output of the ADI-8 DS has to be connected to the word clock input of the first (master) recorder. When using more than one recorder a special sync cable (Tascam part number PW-88S) is needed.

Emphasis

The TDIF interface and the DA-converters of the ADI-8 DS support Emphasis. Please note that an Emphasis indication will not be stored or processed on the sound when doing digital transfers between TDIF and ADAT, because the ADAT standard does not include Emphasis.

6.4 Digital Outputs

The ADI-8 DS provides two digital outputs, both in ADAT optical and TDIF-1 format. In normal operation only the MAIN outputs are used. When using more than the first 4 channels at activated PROCESS BS or DS, the AUX outputs also have to be used.

TDIF and ADAT optical outputs always operate simultaneously and carry the same audio data. As long as PROCESS BS or DS isn't activated MAIN and AUX also operate simultaneously and carry the same audio data. With this it is possible to distribute the output signal to two devices of the same format. When using all connectors the ADI-8 DS can feed up to 4 devices (2 x ADAT, 2 x TDIF).

The ADAT optical outputs of the ADI-8 DS are fully compatible to all ADAT optical inputs. A usual TOSLINK cable is sufficient for connection.

ADAT Main

Interface for the first or only device receiving an ADAT signal from the ADI-8 DS. Carries the channels 1 to 8. When sending a Bit Split or Double Speed signal, this port carries the channels 1 to 4.

ADAT AUX

Copy of the data at the MAIN output. When sending a Bit Split or Double Speed signal, this port carries the channels 5 to 8.

The TDIF-1 connectors of the ADI-8 DS are fully compatible to all devices with such an interface, for example DA-38 and DA-88. The connection is done through a special TDIF cable, available at your local dealer (Tascam part number PW-88D).

TDIF Main

Interface for the first or only device with a TDIF-1 interface. Carries the channels 1 to 8. When transmitting a Bit Split or Double Speed signal, this port carries the channels 1 to 4.

TDIF AUX

Copy of the data at the MAIN interface. Carries the channels 5 to 8 in Bit Split or Double Speed mode.

General hints on TDIF operation

TDIF and word clock

When the ADI-8 DS is slave no additional word clock connection is necessary. In case DA88 and/or DA38 are slave the word clock output of the ADI-8 DS has to be connected to the word clock input of the first (master) recorder. When using more than one recorder a special sync cable (Tascam part number PW-88S) is needed.

Emphasis

The TDIF interface and the DA-converters of the ADI-8 DS support Emphasis. Please note that an Emphasis indication will not be stored or processed on the sound when doing digital transfers between TDIF and ADAT, because the ADAT standard does not include Emphasis.

6.5 Word Clock Input and Output

Input

The ADI-8 DS' word clock input is active, when EXT is chosen in the clock section (see chapter 7, Clock Section). As soon as a valid signal is detected, the EXT LED is constantly lit, otherwise it is flashing slowly.

Thanks to RME's *Signal Adaptation Circuit*, the word clock input still works correctly even with heavily mis-shaped, dc-prone, too small or overshoot-prone signals. Thanks to automatic signal centering, 300 mV (0.3V) input level is sufficient in principle. An additional hysteresis reduces sensitivity to 1.0 V, so that over- and undershoots and high frequency disturbances don't cause a wrong trigger.

The ADI-8 DS' word clock input is shipped as high impedance type (not terminated). A push switch allows to activate internal termination (75 Ohms). The switch is found on the back next to the BNC jack. Use a small pencil or similar and carefully push the blue switch so that it snaps into its lock position. Another push will release it again and de-activate the termination.



Output

The word clock output is constantly active and basically delivers the sample rate of the AD-converter. As long as it is working with internal clock, the output word clock is extremely stable and jitter-free (< 1 ns). The device can even be used as a central word clock generator (except for the limitation of having only one output). In slave mode (EXT/INPUT), the amount of jitter is depending on the input signal.

A word clock signal fed to the ADI-8 DS can even be passed through via the word clock output, because the output signal is phase locked to the input signal (0°). Thus the usual T-adaptor at the input is not needed, and the ADI-8 DS can be used as a signal refresher. This application is even more interesting, because the exceptional input of the ADI-8 DS (1 Vpp sensitivity instead of the usual 2.5 Vpp, dc cut, Signal Adaptation Circuit) guarantees a secure function also with critical word clock signals.

 *The word clock output as well as all ADAT and TDIF ports always operates in Single Speed mode only. At 96 kHz, the word clock output will therefore be a 48 kHz signal.*

Thanks to a low impedance, but short circuit proof output, the ADI-8 DS delivers 4 Vpp to 75 Ohms. For wrong termination with 2 x 75 Ohms (37.5 Ohms), there are still 3.3 Vpp at the output.

7. Clock Section

The ADI-8 DS provides an outstanding clock section with professional features you won't find anywhere else. The unique Intelligent Clock Control (ICC) enables a flexible operation with internal clock (44.1 and 48 kHz, in DS mode 88.2 and 96 kHz), external word clock or the digital input signals. These options are easy to understand and easy to use thanks to a clear display of the corresponding lock and sync state.

A/D

The clock source of the AD-converter can be Internal (quartz crystal), External (BNC word clock) and Input (the digital input signal TDIF or ADAT). Internal 44.1 kHz or 48 kHz sample rate is available. When PROCESS DS is activated the selected sample rate is doubled.

D/A

The same options are available for the DA-converter.

The key DIGITAL INPUT determines the digital input being used, and the clock source in case INPUT was activated before.



As not all combinations of clock settings make sense some of them are blocked. The limitations mainly affect TDIF operation and the setting Clock INTERNAL DA.

Please note that the DA key has priority. In case an allowed combination can't be set simply press the D/A key, set A/D as desired, and set D/A back to its last state.

The Lock state of the ADI-8 DS is indicated by a blinking (error) or constantly lit (Ok) EXT. or INPUT LED in the Clock section.

Clock mode D/A Internal

Clocking the DA-converter from the internal quartz crystal is probably the most outstanding feature of the ADI-8 DS. This technique provides simply the best sound quality, as the internal clock has very low jitter, so that the DA-converters can achieve the highest signal to noise ratio and lowest distortion.



The setting Clock D/A INTERNAL requires a synchronous operation of all devices. To guarantee this the external device connected to the ADI-8 DS has to synchronize itself to the clock from the word clock output or ADAT/TDIF output of the ADI-8 DS.

The ADI-8 DS has to be master, all attached devices slave. To prevent a not better but worse sound quality caused by imperfect or even no synchronisation, a special method called *Sync-Check* compares the synchronicity of the incoming data with the internal clock of the ADI-8 DS. The actual state is indicated by a blinking (error) or constantly lit (Ok) ADAT or TDIF LED in the DIGITAL INPUT section.

In clock mode D/A INTERNAL the clock choices EXTERNAL and INPUT of the AD-section do not make sense, as the clock at the digital output has to be synchronous to the internal clock. Therefore A/D INTERNAL is automatically activated and cannot be changed.

8. Word Clock

8.1 Operation and Technical Background

In the analog domain one can connect any device to another device, synchronization is not necessary. Digital audio is different. Correct interpretation of digital audio data is dependent upon a definite sample frequency. Signals can only be correctly processed or transferred between devices if these all share the same clock. Otherwise digital signals are misinterpreted, causing distortion, clicks/crackle and even dropouts.

AES/EBU, SPDIF and ADAT optical are self-clocking (seen from a non-technical view TDIF too, as word clock is embedded inside the TDIF cable), so an additional line for word clock could be considered redundant. In practice however, using several devices at the same time can cause problems. For example, if devices are connected in a loop without there being a defined 'master' device, self-clocking may break down. Besides, the clocks of all devices must be synchronized from a single source. Devices without SPDIF inputs (typically playback devices such as CD-players) cannot be synchronized via self-clocking. Finally there are 'problematic' devices, which are nearly un-usable without a word clock attached anyway.

In digital studios, synchronization requirements can be met by connecting all devices to a central sync source. For instance, the master device could be a mixing desk, sending a reference signal - word clock - to all other devices. However, this will only work if all the other devices have word clock or sync inputs (e.g. some professional CD-players), allowing them to run as slaves. This being the case, all devices will receive the same clock signal, so there is no fundamental reason for sync problems when they are connected together.

But word clock is not only the 'great problem solver', it also has some disadvantages. The word clock is based on a fraction of the really needed clock. For example SPDIF: 44.1 kHz word clock (a simple square wave signal) has to be multiplied by 128 or 256. This signal then replaces the one from the internal quartz crystal. Because of the high multiplication factor the reconstructed clock will have great deviations called jitter. The jitter of a word clock is much higher as when using a quartz based clock.

The end of these problems should have been the so called Superclock, which uses 256 times the word clock frequency. This equals the internal quartz frequency, so no PLL for multiplying is needed and the clock can be used directly. But reality was different, the Superclock proved to be much more critical than word clock. A square wave signal of 11 MHz distributed to several devices - this simply means to fight with high frequency technology. Reflections, cable quality, capacitive loads - at 44.1 kHz these factors may be ignored, at 11 MHz they are the end of the clock network. Additionally it was found that a PLL not only generates jitter, but also rejects disturbances. The slow PLL works like a filter for induced and modulated frequencies above several kHz. As the Superclock is used without any filtering such a kind of jitter and noise suppression is missing.

The usage of word clock with ADAT optical is critical too. The ADI-8 DS always uses a Bitclock PLL, no matter if the clock reference is word clock or ADAT. Thanks to its very fine resolution this exceptional circuit is able to follow the complete vari-speed range of the ADAT recorder without losing a sample. Many other devices use a much coarser word clock PLL to track the ADAT input. When changing the sample rate (speed) fast, some bits are already sampled invalidly before the frequency is corrected. Drop outs and crackling will be the audible result.

The TDIF format is especially critical with respect to word clock. We have mentioned this in different places of this manual:

When the ADI-8 DD is slave no additional word clock connection is necessary. In case DA88 and/or DA38 are slave the word clock output of the ADI-8 DD has to be connected to the word clock input of the first (master) recorder. When using more than one recorder a special sync cable (Tascam part number PW-88S) is needed.

What you do not need to know: the ADI-8 DS takes care of the first DTRS machine's properties, the DA-88, and it can be used together with this device without further settings.

8.2 Cabling and Termination

Word clock signals are usually distributed in the form of a network, split with BNC T-adapters and terminated with resistors. We recommend using off-the-shelf BNC cables to connect all devices, as this type of cable is used for most computer networks. You will find all the necessary components (T-adapters, terminators, cables) in most electronics and/or computer stores. The latter usually carries 50 Ohm components. The 75 Ohm components used for word clock are part of video technology (RG59).

Ideally, the word clock signal is a 5 Volt square wave with the frequency of the sample rate, of which the harmonics go up to far above 500 kHz.

To avoid voltage loss and reflections, both the cable itself and the terminating resistor at the end of the chain should have an impedance of 75 Ohm. If the voltage is too low, synchronization will fail. High frequency reflection effects can cause both jitter and sync failure.

Unfortunately there are still many devices on the market, even newer digital mixing consoles, which are supplied with a word clock output that can only be called unsatisfactory. If the output breaks down to 3 Volts when terminating with 75 Ohms, you have to take into account that a device, of which the input only works from 2.8 Volts and above, does not function correctly already after 3 meter cable length. So it is not astonishing that because of the higher voltage, word clock networks are in some cases more stable and reliable if cables are not terminated at all.

Ideally all outputs of word clock delivering devices are designed as low impedance types, but all word clock inputs as high impedance types, in order to not weaken the signal on the chain. But there are also negative examples, when the 75 Ohms are built into the device and cannot be switched off. In this case the network load is often 2×75 Ohms, and the user is forced to buy a special word clock distributor. Note that such a device is generally recommended for larger studios.

The ADI-8 DS' word clock input can be high-impedance or terminated internally, ensuring maximum flexibility. If termination is necessary (e.g. because ADI-8 DS is the last device in the chain), push the switch at the back (see chapter 6.5).

In case the ADI-8 DS resides within a chain of devices receiving word clock, plug a T-adapter into its BNC input jack, and the cable supplying the word clock signal to one end of the adapter. Connect the free end to the next device in the chain via a further BNC cable. The last device in the chain should be terminated using another T-adapter and a 75 Ohm resistor (available as short BNC plug). Of course devices with internal termination do not need T-adapter and terminator plug.

9. Special Functions

9.1 Bit Split

Especially digital tape recorders are often limited to 16 bit resolution. To use the complete dynamic range of the ADI-8 DS with such devices the functions BIT SPLIT and COMBINE were integrated. This technique is a simple but effective solution, differently used by several manufacturers.

The method used in the ADI-8 DS is compatible to the one used by Yamaha in their digital mixing desk 02R, so the ADI-8 DS can be used directly in 24 bit operation with this desk. Additionally the COPY MODE (see chapter 8.2 Copy Mode) allows an operation of BIT SPLIT and COMBINE in digital domain. This allows to use the ADAT inputs of the 02R with full 24 bit resolution (normally limited to 20 bit).

BIT SPLIT divides the 24 bit signal into a 16 bit and an 8 bit signal. When recording on 16 bit machines two tracks are required for each channel, an 8 track machine will record 4 channels. To transmit all 8 channels of the ADI-8 DS two digital interfaces (16 tracks) are provided and have to be used.

On the back of the ADI-8 DS two ports of each TDIF and ADAT format named MAIN and AUX can be found.

With PROCESS BS active the analog inputs are processed to the digital outputs as shown below:

Input	1	2	3	4	5	6	7	8
Output Port	1/5 MAIN	2/6 MAIN	3/7 MAIN	4/8 MAIN	1/5 AUX	2/6 AUX	3/7 AUX	4/8 AUX

As long as not more than the first 4 channels are used only the MAIN output is necessary. It makes no sense to connect AUX as it carries no data. When using inputs 5-8 the AUX output also has to be used and carries the data of inputs 5-8.

9.2 Combine

COMBINE BS is the reverse function of BIT SPLIT, putting split signals back together according to the upper table. Again: As long as not more than the first 4 channels are used only the MAIN input is necessary. The AUX input has to be used to receive channels 5-8.

As COMBINE BS is fed from digital inputs a function to verify lock and synchronicity is required. The lock state of the MAIN input is indicated as usual by the LEDs of the Clock D/A section. The input AUX has its own lock/sync LED at the key COMBINE. This LED operates in a slightly different way, as it indicates both Lock and Sync state.



As long as no signal is found at the AUX input the SYNC LED will be off. When a valid signal is fed the LED begins to flash (lock state). When the data received is synchronous to the data at the input MAIN the LED will stay lit (lock+sync state). This securely indicates and prevents audio errors in COMBINE mode.

9.3 Copy Mode

The function COPY MODE turns the ADI-8 DS into an outstanding ADAT to TDIF and TDIF to ADAT format converter, a digital patchbay, a signal distributor and a digital 16/24 bit converter.

When COPY MODE is active the digital input signal of the DA-converter is routed directly to the digital outputs of the AD-converter. The AD-converter can't be used anymore. That's why the complete AD clock section will also be disabled. All LEDs of the AD-section (INPUT LEVEL, OK, OVR, INPUT, EXT., INT.) will be off. PROCESS is still available (see below). As usual the digital input signal is available at the analog outputs for monitoring purposes.

In COPY MODE the digital input is set by the key DIGITAL INPUT, the output signal shows up at ADAT out and TDIF simultaneously. This allows to convert a signal from ADAT optical to TDIF-1 or vice versa. Additionally it is possible to copy the input signal directly to a device of the same format, without the need of changing connectors or cables.

As long as PROCESS BS or DS isn't activated MAIN and AUX ports also operate simultaneously and carry the same audio data. With this it is possible to distribute the output signal to two devices of the same format. For example an ADAT optical signal can be distributed to 2 ADAT and 2 TDIF devices at the same time.

In COPY MODE all extended functions (PROCESS BS/DS, COMBINE BS/DS, DITHER) are available, so besides direct copying and format conversion between ADAT optical and TDIF it is also possible to re-combine a split signal while copying, or split a not split signal, or recombine and split again into another format.

 *When Bit Split or Double Speed is activated the distribution/copying within one format is not available, as MAIN and AUX carry different data.*

Please note the Block Diagram on page 21. It shows the complete signal path within the ADI-8 DS, in an easy to understand way, also in activated COPY MODE.

Emphasis

The TDIF interface and the DA-converters of the ADI-8 DS support Emphasis. Please note that an Emphasis indication will not be stored or processed on the sound when doing digital transfers between TDIF and ADAT, because the ADAT standard does not include Emphasis.

9.4 Dither

Thanks to BIT SPLIT and COMBINE the ADI-8 DS preserves full 24 bit resolution even when working with 16 bit devices. It may happen that the actual recording situation does not allow a usage of BIT SPLIT/COMBINE. When using Double Speed (88.2 and 96 kHz) BIT SPLIT/COMBINE is not available. When transferring to a 16-bit medium, the word length is reduced by discarding the lower bits. This truncation causes distortion at the low-level components of the signal.

To combat this 'quantisation distortion', noise at a level corresponding to the least-significant bit - or below - is added to the signal before truncation, randomly modulating the signal. This process is called 'dithering'.

In most cases Dither can be dispensed with altogether. If you would like to know more about this view (which some might consider provocative), please read the Tech Info '*Dither ADI-1 / ADI-8 PRO: Remarks about the Need for Dither*' on our website. To summarize: External dithering is unnecessary if the sum of noise from the source as well as from the A/D converter is above a certain threshold. And when using DC-free AD-converters truncating signals outside the 16-bit range does not cause them to disappear altogether, but only changes their levels slightly.

Dither is used when reducing the word length from 24 to 20 or 16 bit. Activating the function PROCESS DITHER is helpful when recording the hi-resolution signal of the ADI-8 DS to any 16 bit destination, preventing distortion at very low levels caused by truncation. Apart from the above notes, there are other good reasons why you can safely do without dither in the ADI-8 DS:

- Transferring to 20-bit (such as ADAT XT or O2R) does not require dither, as the maximum dynamic range of the ADI-8 DS is 'only' 18.8 bit (or 113 dB), fitting completely into a 20-bit (120 dB) system.
- Transferring data to a computer can be done in 20 or 24-bit word length. Dither then is added at the very end of the chain, i.e. after all editing and mixing has been done.

Please note that Dither is most helpful at the end of the recording chain, at mastering down to 2 tracks and 16 bit.

9.5 DS - Double Speed

When activating the *Double Speed* mode the ADI-8 DS operates at double sample rate. The internal clock 44.1 kHz turns to 88.2 kHz, 48 kHz to 96 kHz. With this the device is able to process even ultra-sound above 40 kHz at its analog inputs and outputs. AD/DA-converter and COPY mode still use full 24 bit resolution.

The ADAT optical interface does not support sample rates above 48 kHz. Therefore the converter uses a *Sample Split* method, which operates similar to the BIT SPLIT function. Single channel data is split to 2 channels according to the following table:

Original	1	2	3	4	5	6	7	8
DS Signal	1/2	3/4	5/6	7/8	1/2	3/4	5/6	7/8
Port	MAIN	MAIN	MAIN	MAIN	AUX	AUX	AUX	AUX

This method of transmitting double speed data at single speed is known as *double wire* throughout the professional audio world, and also known under the name *S/MUX* regarding ADAT interfaces. Tascam also uses this method in their latest DTRS recorder DA-98HR, but calls it *Dual Line*.

The table is valid for all directions (AD - DA - DD). As the AUX port is already used for DS the function BIT SPLIT is not available simultaneously.

As the transmission of double rate signals is done at standard sample rate (Single Speed) the word clock output still delivers 44.1 kHz or 48 kHz. The same is true for the word clock input, where only 44.1 kHz or 48 kHz are expected.

 *The word clock input and output as well as all ADAT and TDIF ports always operate in Single Speed mode only. At 96 kHz, the word clock output will therefore be a 48 kHz signal.*

The TDIF interface of the ADI-8 DS also supports the 'Double Wire' technique. This allows a recording with up to 96 kHz at halved track numbers with every (!) DTRS device.

Note: The ideal combination is an ADI-8 DS together with the digital I/O card **RME HDSP 9652**. This allows to simultaneously record and playback 8 tracks at 24 bit/96 kHz, using PC or Mac.

9.6 Noise level in DS operation

The outstanding signal to noise ratio of the ADI-8 DS can be verified even without expensive test equipment, by using our famous *DIGICheck* tool or the record level meter of *WaveLab 3.0*. When activating the DS mode the displayed noise level will rise from -113 dB to -100 dB. This is not a failure. This kind of measurement measures the noise of the whole frequency range, at 96 kHz from 0 Hz to 48 kHz (RMS unweighted). When limiting the measured area to 22 kHz (audio bandpass, weighted) the value would be -110 dB again.

The reason for this behaviour is the noise shaping technology used in the ADI-8 DS' analog to digital converters. They move all noise and distortion to the in-audible higher frequency range, above 24 kHz. That's how they achieve their outstanding performance and sonic clarity. Therefore the noise is slightly increased in the ultrasound area. High-frequent noise has a high energy. Add the doubled bandwidth (which already lowers the measured SNR by 3 dB), and a wideband measurement will show a drop of 10 dB in SNR, while the human ear will notice absolutely no change in the audible noise floor.

10. Controls and Connectors

Front

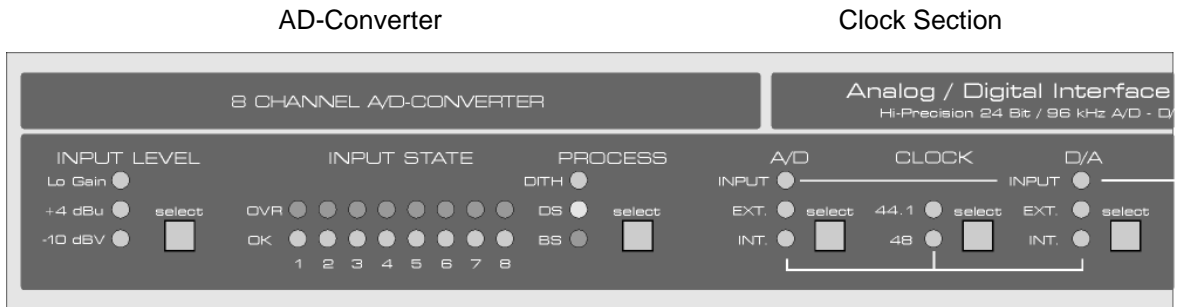

Select Input Level
+4 dBu, -10 dBV
Lo Gain

Level Indication
OK = -40 dBFS
OVR= Overload

Dither
Double Speed
Bit Split

Clock Section AD and DA
INPUT= Digital input signal
EXT.= Word clock signal
INT.= Crystal 44.1 or 48 kHz

DA-Converter

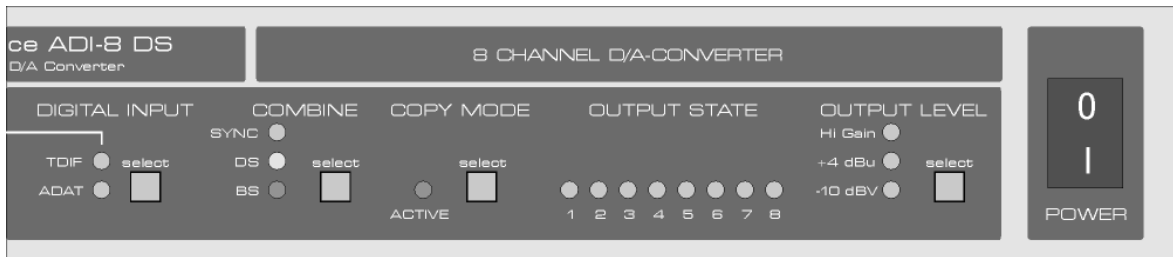

Digital Input
TDIF or ADAT

AUX Sync
Double Speed
Bit Split

Copy Mode

Signal OK
-40 dBFS

Select Output Level
Hi Gain,
+4 dBu, -10 dBV

On/Off
Power

Rear

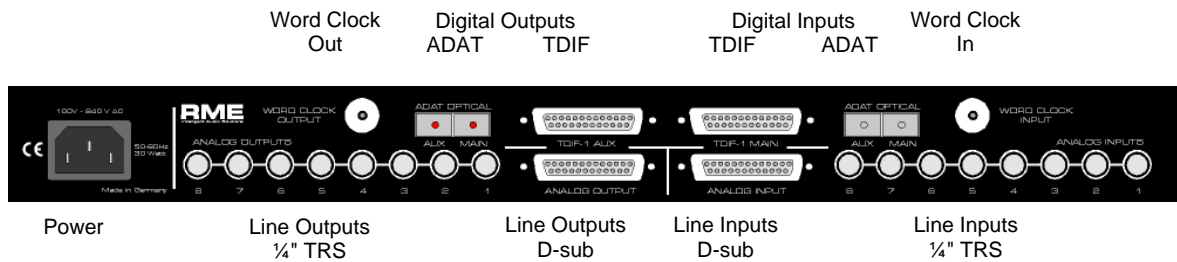

Power

Line Outputs
1/4" TRS

Line Outputs
D-sub

Line Inputs
D-sub

Line Inputs
1/4" TRS

11. Connector Pinouts

D-Sub analog input / output

The 25 pin D-sub connectors of analog input and output are wired as shown in this table:

Channel	1+	1-	2+	2-	3+	3-	4+	4-	5+	5-	6+	6-	7+	7-	8+	8-
D-sub	24	12	10	23	21	9	7	20	18	6	4	17	15	3	1	14

GND is connected to pins 2, 5, 8, 11, 16, 19, 22, 25. Pin 13 is unconnected.

D-Sub TDIF-1

The 25 pin D-sub connectors are wired according to TDIF-1, version 1.1:

Signal	Out 1/2	Out 3/4	Out 5/6	Out 7/8	Out LRCK	Out EMPH	Out FS0	Out FS1
D-sub	1	2	3	4	5	18	6	19

Signal	In FS1	In FS0	In EMPH	In LRCK	In 7/8	In 5/6	In 3/4	In 1/2
D-sub	20	8	21	9	10	11	12	13

GND is connected to pins 7, 14, 15, 16, 17, 22, 23, 24, 25.

TRS-jacks of analog input / output

The stereo ¼" TRS jacks of the analog inputs and outputs are wired according to international standards:

Tip = + (hot)

Ring = - (cold)

The servo balanced input and output circuitry allows to use monaural TS jacks (unbalanced) with no loss in level. This is the same as when using a TRS-jack with ring connected to ground.

12. Block Diagram

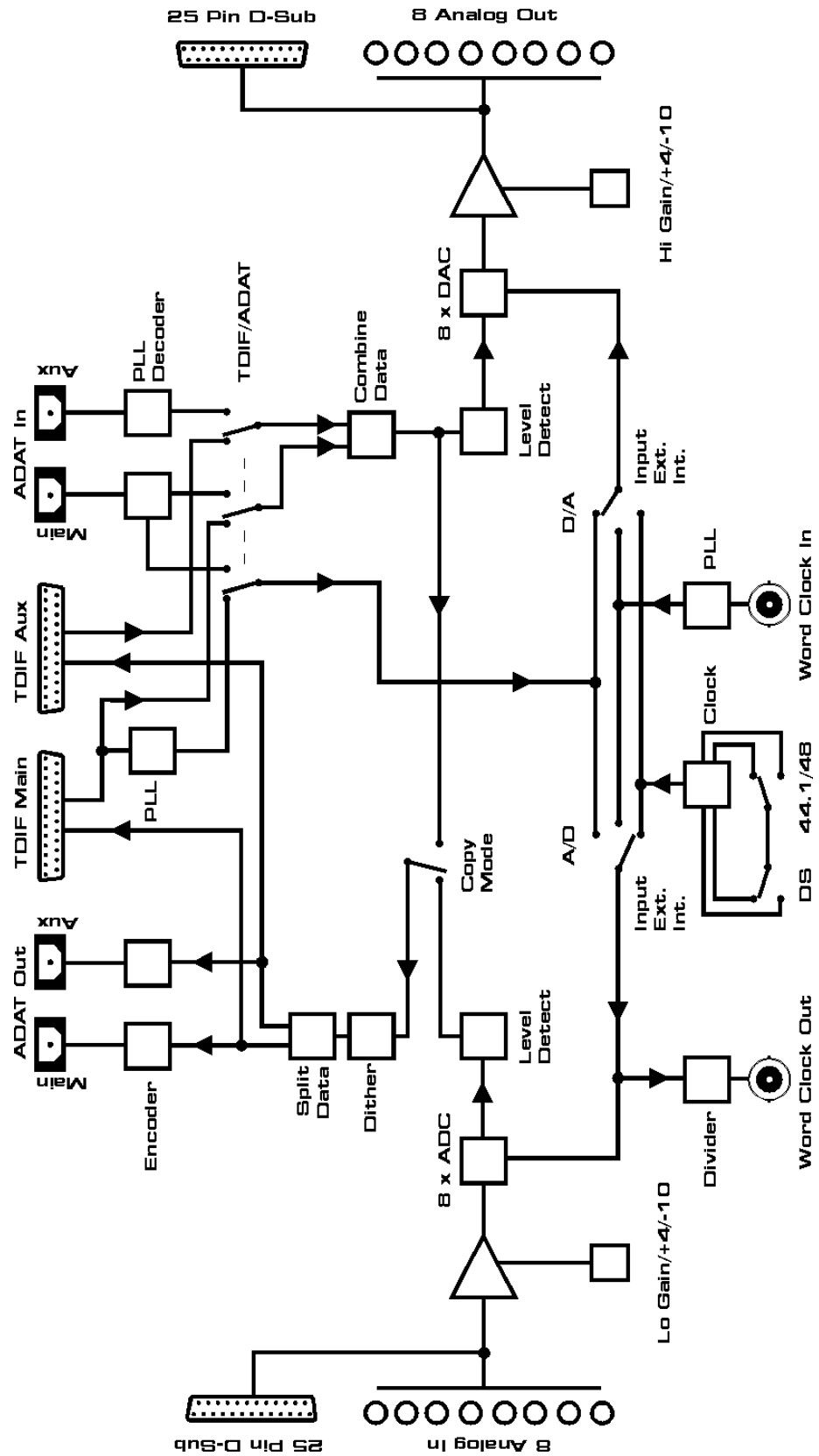

13. Warranty

Each individual ADI-8 DS undergoes comprehensive quality control and a complete test at IMM before shipping. The usage of high grade components should guarantee a long and trouble-free operation of the unit.

If you suspect that your product is faulty, please contact your local retailer.

Audio AG grants a limited manufacturer warranty of 6 months from the day of invoice showing the date of sale. The length of the warranty period is different per country. Please contact your local distributor for extended warranty information and service. Note that each country may have regional specific warranty implications.

In any case warranty does not cover damage caused by improper installation or maltreatment - replacement or repair in such cases can only be carried out at the owner's expense.

No warranty service is provided when the product is not returned to the local distributor in the region where the product had been originally shipped.

Audio AG does not accept claims for damages of any kind, especially consequential damage. Liability is limited to the value of the ADI-8 DS. The general terms of business drawn up by Audio AG apply at all times.

14. Appendix

RME news and further information on our products can be found on our website:

<http://www.rme-audio.com>

Distributor: Audio AG, Am Pfanderling 60, D-85778 Haimhausen, Tel.: (49) 08133 / 91810

Manufacturer:

IMM Elektronik GmbH, Leipziger Strasse 32, D-09648 Mittweida

Trademarks

All trademarks and registered trademarks belong to their respective owners. RME, Hammerfall and DIGICheck are registered trademarks of RME Intelligent Audio Solutions. Intelligent Clock Control, SyncAlign, DIGI96, ZLM, SyncCheck and Fireface are trademarks of RME Intelligent Audio Solutions. Alesis and ADAT are registered trademarks of Alesis Corp. ADAT optical is a trademark of Alesis Corp. TDIF is a trademark of TEAC Corp. WaveLab is a trademark of Steinberg Media Technologies AG.

Copyright © Matthias Carstens, 03/2011. Version 1.8

All entries in this User's Guide have been thoroughly checked for errors, however no guarantee for correctness can be given. RME cannot be held responsible for any misleading or incorrect information provided throughout this manual. Lending or copying any part or the complete manual or its contents as well as the software belonging to it is only possible with the written permission from RME. RME reserves the right to change specifications at any time without notice.

CE / FCC Compliance

CE

This device has been tested and found to comply with the limits of the European Council Directive on the approximation of the laws of the member states relating to electromagnetic compatibility according to RL2004/108/EG, and European Low Voltage Directive RL2006/95/EG.

FCC

This equipment has been tested and found to comply with the limits for a Class B digital device, pursuant to Part 15 of the FCC Rules. These limits are designed to provide reasonable protection against harmful interference in a residential installation. This equipment generates, uses, and can radiate radio frequency energy and, if not installed and used in accordance with the instructions, may cause harmful interference to radio communications. However, there is no guarantee that interference will not occur in a particular installation. If this equipment does cause harmful interference to radio or television reception, which can be determined by turning the equipment off and on, the user is encouraged to try to correct the interference by one or more of the following measures:

- Reorient or relocate the receiving antenna.
- Increase the separation between the equipment and receiver.
- Connect the equipment into an outlet on a circuit different from that to which the receiver is connected.
- Consult the dealer or an experienced radio/TV technician for help.

RoHS

This product has been soldered lead-free and fulfils the requirements of the RoHS directive.

ISO 9001

This product has been manufactured under ISO 9001 quality management. The manufacturer, IMM Elektronik GmbH, is also certified for ISO 14001 (Environment) and ISO 13485 (medical devices).

Note on Disposal

According to the guide line RL2002/96/EG (WEEE – Directive on Waste Electrical and Electronic Equipment), valid for all european countries, this product has to be recycled at the end of its lifetime.

In case a disposal of electronic waste is not possible, the recycling can also be done by IMM Elektronik GmbH, the manufacturer of the ADI-8 DS.

For this the device has to be sent **free to the door** to:

IMM Elektronik GmbH
Leipziger Straße 32
D-09648 Mittweida
Germany



Shipments not prepaid will be rejected and returned on the original sender's costs.